

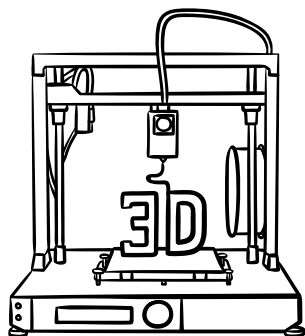

ATELIER AUTHENTIQUE

Artisanat & Innovation



**IMPRESSION
3D**

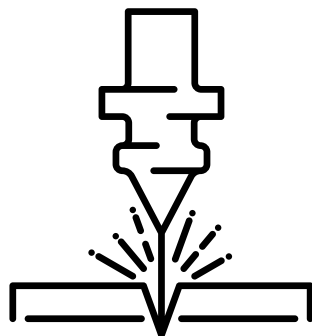

**GRAVURE ET
DÉCOUPE
LASER**

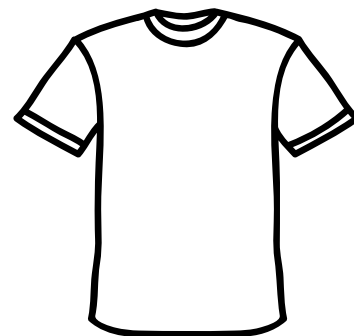

**IMPRESSION
SUR TEXTILE**

**CRÉATION
UNIQUE & SUR-MESURE**

Lucas SELLA



06-23-58-60-45



contact@atelier-authentique.com



**14 Rue Laurent Fauchier
13 100 Aix-en-Provence**



<https://atelier-authentique.fr>

CRÉATION SUR MESURE

Que vous cherchiez des cadeaux uniques pour vos clients, des pièces sur mesure pour votre espace professionnel ou des articles promotionnels personnalisés, notre équipe est prête à **donner vie à vos idées.**

Chez ATELIER AUTHENTIQUE, nous mettons notre passion dans la création d'objets uniques qui reflètent l'identité de votre entreprise. Grâce à notre savoir-faire artisanal et à l'utilisation de machine de pointe nous **personnalisons chaque détail** pour répondre aux exigences de votre secteur d'activité.

Nous accordons une importance particulière à la **qualité** des matériaux utilisés et à la **précision** de notre travail. Chaque commande personnalisée est réalisée avec soin.

Que vous ayez une vision claire en tête ou que vous cherchiez de l'inspiration, notre équipe experte est là pour vous guider tout au long du processus.

Contactez-nous dès aujourd'hui pour plus d'information !



PORTE CLÉ



Dimension: 45 x 32 x 7 mm

Matériau: Cuir - Acier inoxydable

Gravure: Dessin - Logo - Texte

| | | | | | | |
|---------------------|------------|------------|------------|-----------|-----------|-----------|
| QUANTITÉ | 1 | 15 | 30 | 50 | 100 | 200 |
| TARIF UNITAIRE | 12,00 € | 10,00 € | 8,00 € | 4,50 € | 3,50 € | 2,00 € |
| TARIF RECTO & VERSO | 15,00 € | 13,00 € | 10,50 € | 6,50 € | 5,50 € | 3,50 € |

PORTE CLÉ



Dimension: 45 x 32 x 7 mm

Matériau: Bois hévéa - Acier inoxydable

Gravure: Photo - Dessin - Logo - Texte

| QUANTITÉ | 1 | 15 | 30 | 50 | 100 | 200 |
|---------------------|------------|------------|------------|-----------|-----------|-----------|
| TARIF UNITAIRE | 12,00 € | 10,00 € | 8,00 € | 4,50 € | 3,50 € | 2,00 € |
| TARIF RECTO & VERSO | 15,00 € | 13,00 € | 10,50 € | 6,50 € | 5,50 € | 3,50 € |

MAGNET

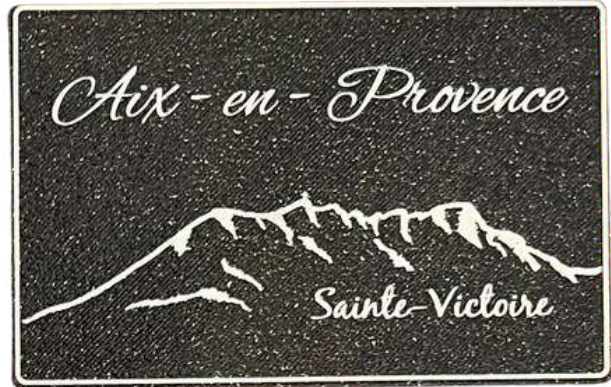
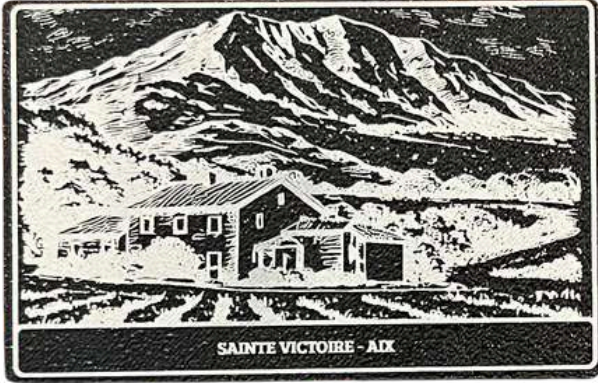

Dimension: 70 x 45 x 4 mm

Matériau: PLA noir

Gravure: Photo - Dessin - Logo - Texte

| QUANTITÉ | 1 | 15 | 30 | 50 | 100 | 200 |
|----------------|------------|-----------|-----------|-----------|-----------|-----------|
| TARIF UNITAIRE | 12,00 € | 8,00 € | 5,50 € | 4,50 € | 3,50 € | 2,35 € |

ROND DE SERVIETTE



Dimension: 50 mm

Matériau: Bois hévéa

Gravure: Dessin - Logo - Texte

| QUANTITÉ | 1 | 15 | 30 | 50 | 100 | 200 |
|---------------------|------------|------------|------------|-----------|-----------|-----------|
| TARIF UNITAIRE | 12,00 € | 10,00 € | 8,00 € | 5,00 € | 4,00 € | 3,60 € |
| TARIF RECTO & VERSO | 15,00 € | 13,00 € | 10,50 € | 7,00 € | 6,00 € | 5,10 € |

BOUCHON



Dimension: 25 mm

Matériau: Bois hévéa - Caoutchouc

Gravure: Dessin - Logo - Texte

| | | | | | | |
|----------------|-----------|-----------|-----------|-----------|-----------|-----------|
| QUANTITÉ | 1 | 15 | 30 | 50 | 100 | 200 |
| TARIF UNITAIRE | 4,00 € | 3,30 € | 3,00 € | 2,80 € | 2,50 € | 2,00 € |

DECAPSULEUR



Dimension: 137 x 28 x 19 mm

Matériau: Bois hénéa - Acier inoxydable

Gravure: Dessin - Logo - Texte

| QUANTITÉ | 1 | 15 | 30 | 50 | 100 | 200 |
|---------------------|------------|------------|------------|-----------|-----------|-----------|
| TARIF UNITAIRE | 12,00 € | 10,00 € | 8,00 € | 5,50 € | 4,50 € | 3,90 € |
| TARIF RECTO & VERSO | 15,00 € | 13,00 € | 10,50 € | 7,50 € | 6,50 € | 5,40 € |

LIMONADIER



Dimension: 120 mm

Matériau: Bois - Acier inoxydable

Gravure: Dessin - Logo - Texte

| | | | | | | |
|------------------------|------------|------------|------------|------------|------------|------------|
| QUANTITÉ | 1 | 15 | 30 | 50 | 100 | 200 |
| TARIF UNITAIRE | 25,00 € | 23,00 € | 18,00 € | 14,00 € | 12,00 € | 11,10 € |
| TARIF RECTO & VERSO | 28,00 € | 26,00 € | 20,50 € | 16,00 € | 14,00 € | 12,60 € |

STYLO



Dimension: 137 x 11 mm

Matériau: Bois de bambou

Gravure: Dessin - Logo - Texte

| QUANTITÉ | 1 | 15 | 30 | 50 | 100 | 200 |
|---------------------|------------|-----------|-----------|-----------|-----------|-----------|
| TARIF UNITAIRE | 7,00 € | 6,50 € | 5,00 € | 3,60 € | 2,45 € | 1,35 € |
| TARIF RECTO & VERSO | 10,00 € | 8,50 € | 7,00 € | 5,10 € | 3,95 € | 2,35 € |

CROCHET PORTE



Dimension: Sur mesure

Matériau: Contreplaqué de tilleul

Gravure: Photo - Dessin - Logo - Texte

| QUANTITÉ | 1 | 15 | 30 | 50 | 100 | 200 |
|---------------------|------------|------------|------------|-----------|-----------|-----------|
| TARIF UNITAIRE | 12,00 € | 11,00 € | 9,00 € | 7,00 € | 6,00 € | 4,50 € |
| TARIF RECTO & VERSO | 15,00 € | 14,00 € | 11,80 € | 9,20 € | 8,20 € | 6,00 € |

MARQUE PAGE



Dimension: 120 x 35 x 3 mm

Matériau: Contreplaqué de tilleul

Gravure: Photo - Dessin - Logo - Texte

| QUANTITÉ | 1 | 15 | 30 | 50 | 100 | 200 |
|---------------------|------------|------------|------------|-----------|-----------|-----------|
| TARIF UNITAIRE | 12,00 € | 10,00 € | 8,00 € | 4,50 € | 3,50 € | 2,00 € |
| TARIF RECTO & VERSO | 15,00 € | 13,00 € | 10,80 € | 6,00 € | 5,50 € | 3,50 € |

ÉVENTAIL

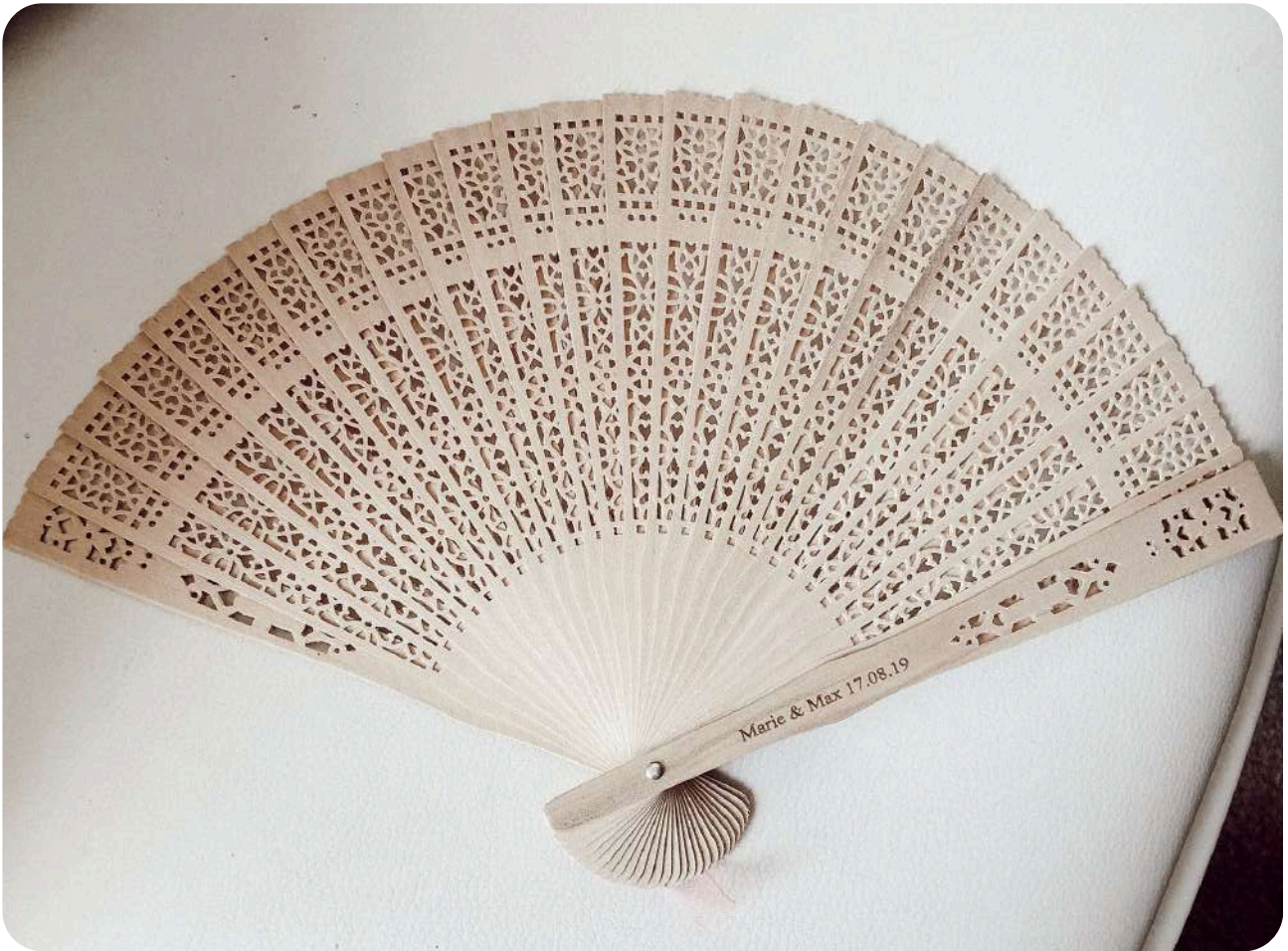

Dimension: 200 x 27 mm

Matériau: Bois

Gravure: Dessin - Logo - Texte

| | | | | | | |
|------------------------------------|------------|------------|-----------|-----------|------------|------------|
| QUANTITÉ | 1 | 15 | 30 | 50 | 100 | 200 |
| TARIF UNITAIRE | 8,00 € | 7,00 € | 6,50 € | 6,00 € | 5,50 € | 4,50 € |
| TARIF RECTO & VERSO | 11,00 € | 10,00 € | 9,50 € | 8,75 € | 8,00 € | 7,00 € |

MIROIR



Dimension: 70 x 9 mm

Matériau: Bois de Bambou

Gravure: Dessin - Logo - Texte

| | | | | | | |
|-------------------|------------|------------|-----------|-----------|-----------|-----------|
| QUANTITÉ | 1 | 15 | 30 | 50 | 100 | 200 |
| TARIF UNITAIRE | 12,00 € | 10,00 € | 8,00 € | 5,50 € | 4,50 € | 3,90 € |

CARNET



Dimension: 97 x 144 mm

Matériau: Kraft

Gravure: Dessin - Logo - Texte

| QUANTITÉ | 1 | 15 | 30 | 50 | 100 | 200 |
|---------------------|------------|------------|------------|-----------|-----------|-----------|
| TARIF UNITAIRE | 12,00 € | 10,00 € | 8,00 € | 5,50 € | 4,50 € | 3,90 € |
| TARIF RECTO & VERSO | 15,00 € | 13,00 € | 10,50 € | 7,50 € | 6,50 € | 5,40 € |

CARNET

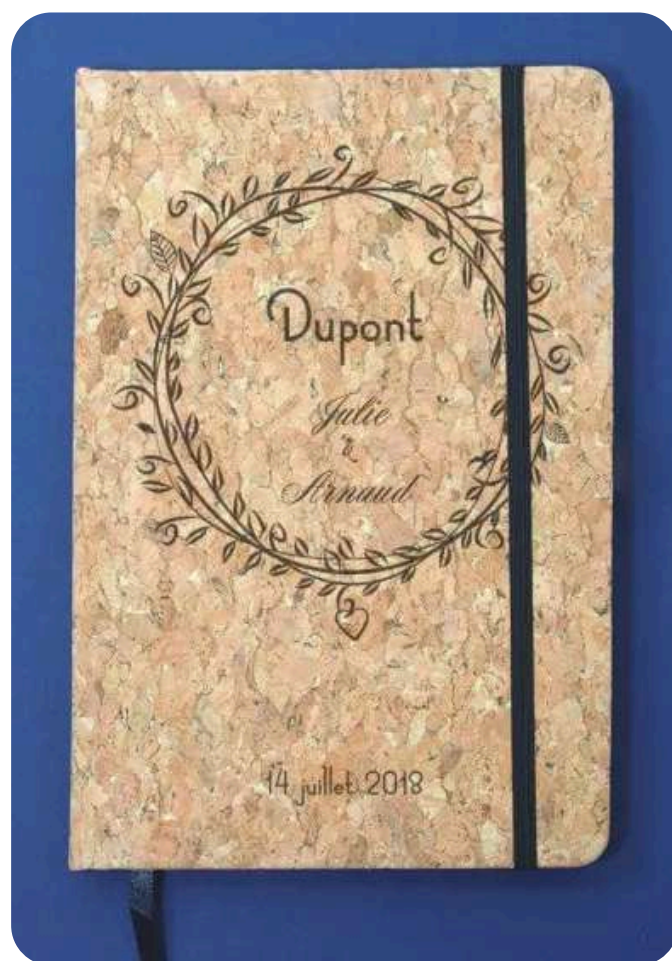

Dimension: 140 x 90 mm

Matériau: Liège

Gravure: Dessin - Logo - Texte

| QUANTITÉ | 1 | 15 | 30 | 50 | 100 | 200 |
|------------------------|------------|------------|------------|-----------|-----------|-----------|
| TARIF UNITAIRE | 15,00 € | 12,00 € | 9,00 € | 7,00 € | 5,50 € | 4,90 € |
| TARIF RECTO & VERSO | 18,00 € | 15,00 € | 11,50 € | 9,00 € | 7,50 € | 6,40 € |

CARNET



Dimension: 165 x 210 mm

Matériau: Kraft

Gravure: Dessin - Logo - Texte

| QUANTITÉ | 1 | 15 | 30 | 50 | 100 | 200 |
|---------------------|------------|------------|------------|------------|-----------|-----------|
| TARIF UNITAIRE | 25,00 € | 20,00 € | 15,00 € | 9,50 € | 7,50 € | 5,90 € |
| TARIF RECTO & STYLO | 28,00 € | 23,00 € | 17,50 € | 11,50 € | 9,50 € | 7,40 € |

CARNET

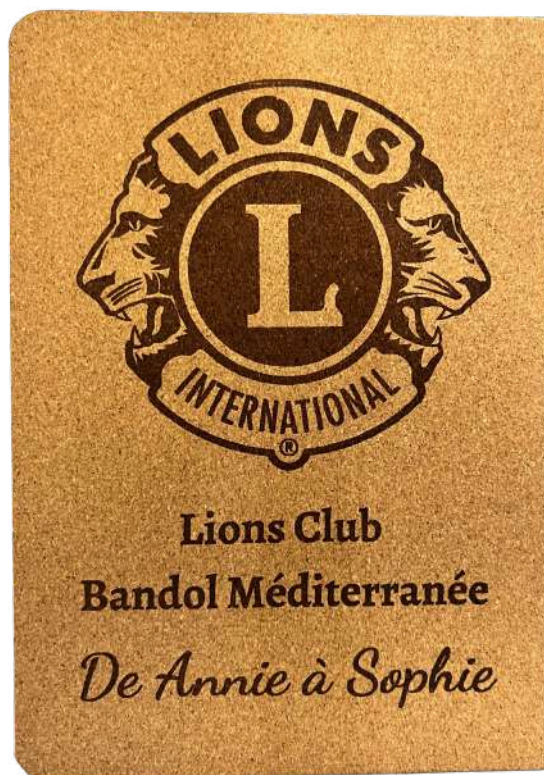

Dimension: 130 x 180 mm

Matériau: Liège

Gravure: Dessin - Logo - Texte

| QUANTITÉ | 1 | 15 | 30 | 50 | 100 | 200 |
|------------------------|------------|------------|------------|------------|------------|------------|
| TARIF UNITAIRE | 25,00 € | 21,00 € | 18,00 € | 15,00 € | 12,00 € | 10,50 € |
| TARIF RECTO & VERSO | 30,00 € | 24,00 € | 20,50 € | 17,00 € | 14,00 € | 12,00 € |

SOUS-VERRE



Dimension: 100 x 2 mm

Matériau: Liège

Gravure: Dessin - Logo - Texte

| QUANTITÉ | 1 | 15 | 30 | 50 | 100 | 200 |
|------------------------|-----------|-----------|-----------|-----------|-----------|-----------|
| TARIF UNITAIRE | 5,00 € | 3,75 € | 3,60 € | 3,45 € | 3,20 € | 1,90 € |
| TARIF RECTO & VERSO | 8,00 € | 6,75 € | 6,60 € | 6,20 € | 5,70 € | 3,40 € |

SOUS-VERRE

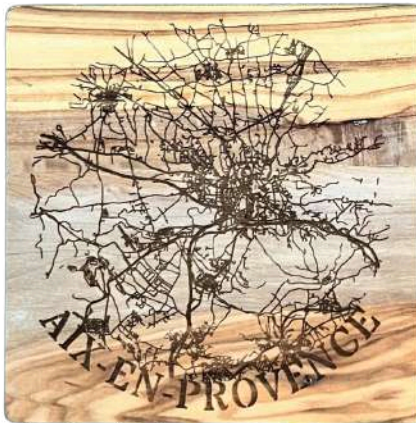

Dimension: 90 x 90 x 6 mm

Matériau: Bois d'olivier

Gravure: Dessin - Logo - Texte

| QUANTITÉ | 1 | 15 | 30 | 50 | 100 | 200 |
|---------------------|------------|------------|------------|-----------|-----------|-----------|
| TARIF UNITAIRE | 10,00 € | 7,50 € | 7,25 € | 6,50 € | 5,80 € | 4,95 € |
| TARIF RECTO & VERSO | 13,00 € | 10,50 € | 10,25 € | 8,50 € | 7,80 € | 6,45 € |

SOUS-VERRE



Dimension: 10 x 10 x 4 mm

Matériau: Ardoise

Gravure: Photo - Dessin - Logo - Texte

| QUANTITÉ | 1 | 15 | 30 | 50 | 100 | 200 |
|---------------------|------------|------------|------------|-----------|-----------|-----------|
| TARIF UNITAIRE | 10,00 € | 7,50 € | 7,00 € | 5,00 € | 3,90 € | 2,80 € |
| TARIF RECTO & VERSO | 13,00 € | 10,50 € | 10,00 € | 7,00 € | 5,90 € | 4,30 € |

SOUS-PLAT



Dimension: 193 x 10 mm

Matériau: Liège

Gravure: Photo - Dessin - Logo - Texte

| QUANTITÉ | 1 | 15 | 30 | 50 | 100 | 200 |
|---------------------|------------|------------|------------|------------|------------|------------|
| TARIF UNITAIRE | 15,00 € | 13,50 € | 12,00 € | 10,00 € | 8,00 € | 7,00 € |
| TARIF RECTO & VERSO | 20,00 € | 18,50 € | 17,00 € | 14,50 € | 12,00 € | 11,00 € |

PLANCHE À DÉCOUPER

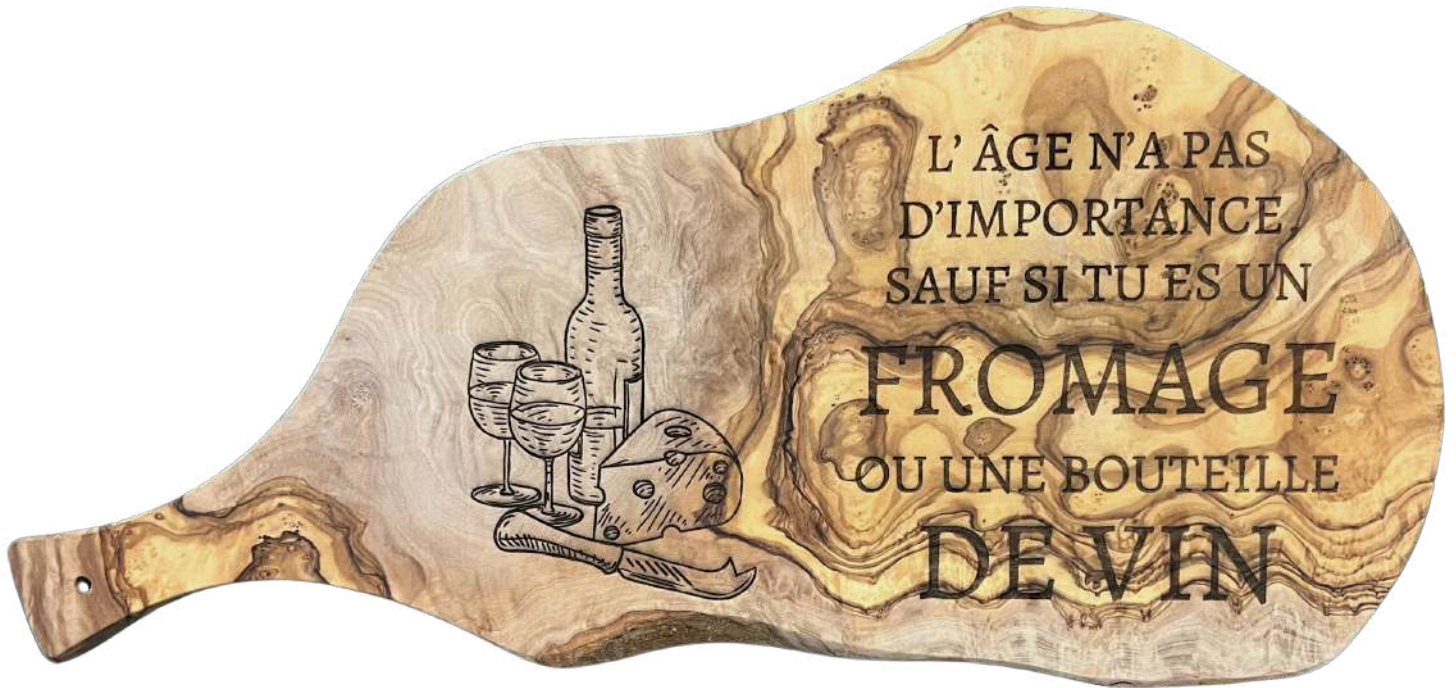

Dimension: 400 - 440 x 17 - 20 mm

Matériau: Bois d'olivier

Gravure: Dessin - Logo - Texte

| | | | | | | |
|----------------|------------|------------|------------|------------|------------|------------|
| QUANTITÉ | 1 | 15 | 30 | 50 | 100 | 200 |
| TARIF UNITAIRE | 79,00 € | 77,00 € | 75,00 € | 70,00 € | 60,00 € | 55,00 € |

PLANCHE À DÉCOUPER



Dimension: 230 - 250 x 17 - 20 mm

Matériau: Bois d'olivier

Gravure: Dessin - Logo - Texte

| QUANTITÉ | 1 | 15 | 30 | 50 | 100 | 200 |
|-------------------|------------|------------|------------|------------|------------|------------|
| TARIF UNITAIRE | 39,00 € | 37,00 € | 35,00 € | 30,00 € | 27,00 € | 25,00 € |

SPATULE

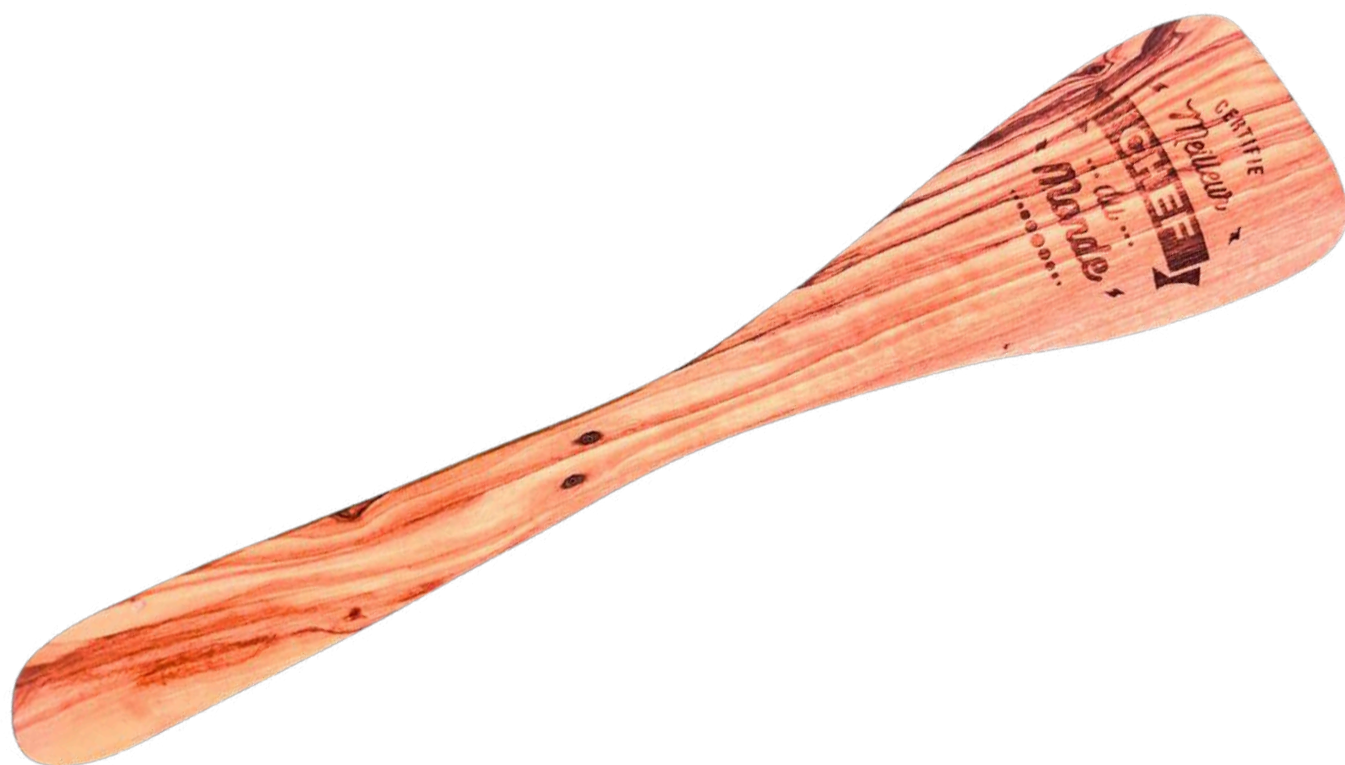

Dimension: 310 x 65 mm

Matériau: Bois d'olivier

Gravure: Dessin - Logo - Texte

| QUANTITÉ | 1 | 15 | 30 | 50 | 100 | 200 |
|------------------------|------------|------------|------------|------------|------------|------------|
| TARIF UNITAIRE | 15,00 € | 13,50 € | 12,00 € | 10,00 € | 8,00 € | 7,50 € |
| TARIF RECTO & VERSO | 18,00 € | 16,50 € | 15,00 € | 12,75 € | 10,50 € | 10,00 € |

PLANCHE À DÉCOUPER



Dimension: 340 x 140 x 13 mm

Matériau: Bois de hêtre

Gravure: Dessin - Logo - Texte

| QUANTITÉ | 1 | 15 | 30 | 50 | 100 | 200 |
|----------------|------------|------------|------------|------------|------------|------------|
| TARIF UNITAIRE | 35,00 € | 28,00 € | 17,00 € | 13,50 € | 11,50 € | 10,80 € |

PLANCHE À DÉCOUPER



Dimension: 490 x 170 x 20 mm

Matériau: Bois de hêtre

Gravure: Dessin - Logo - Texte

| QUANTITÉ | 1 | 15 | 30 | 50 | 100 | 200 |
|----------------|------------|------------|------------|------------|------------|------------|
| TARIF UNITAIRE | 49,00 € | 40,00 € | 35,00 € | 25,00 € | 23,00 € | 21,00 € |

PLANCHE À DÉCOUPER



Dimension: 380 x 200 x 20 mm

Matériau: Bois de hêtre

Gravure: Dessin - Logo - Texte

| | | | | | | |
|-------------------|------------|------------|------------|------------|------------|------------|
| QUANTITÉ | 1 | 15 | 30 | 50 | 100 | 200 |
| TARIF UNITAIRE | 49,00 € | 40,00 € | 35,00 € | 25,00 € | 23,00 € | 21,00 € |

PLANCHE



Dimension: 300 x 200 mm

Matériau: Ardoise

Gravure: Photo - Dessin - Logo - Texte

| QUANTITÉ | 1 | 15 | 30 | 50 | 100 | 200 |
|-------------------|------------|------------|------------|------------|------------|------------|
| TARIF UNITAIRE | 39,00 € | 37,00 € | 35,00 € | 25,00 € | 23,00 € | 21,00 € |

PLANCHE



Dimension: 300 x 110 mm

Matériau: Ardoise

Gravure: Photo - Dessin - Logo - Texte

| QUANTITÉ | 1 | 15 | 30 | 50 | 100 | 200 |
|----------------|------------|------------|------------|------------|------------|------------|
| TARIF UNITAIRE | 25,00 € | 23,50 € | 22,00 € | 20,00 € | 17,00 € | 15,00 € |

PLV - TABLEAU

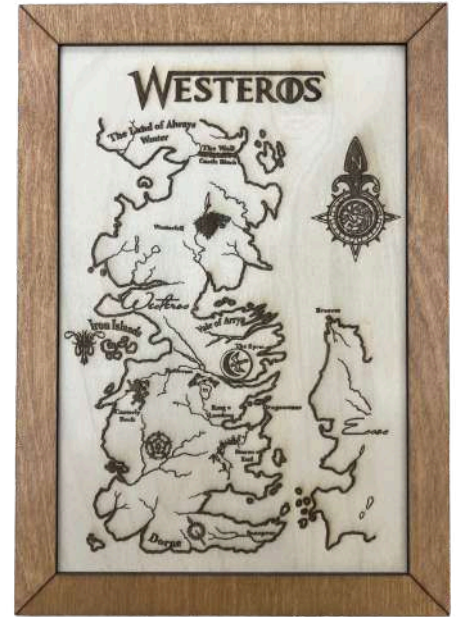
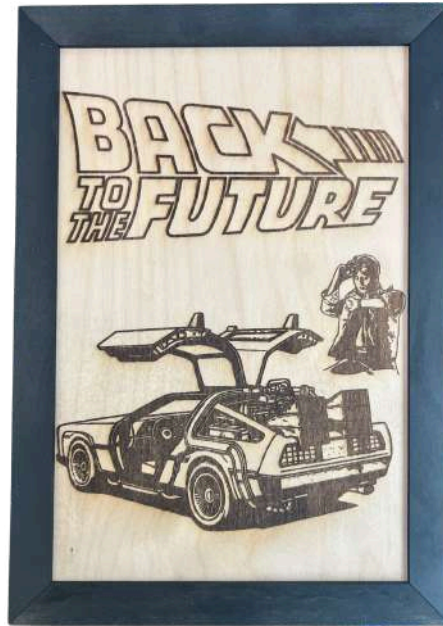

Dimension: A4 x 3 mm

Matériau: Contreplaqué de Tilleul

Gravure: Photo - Dessin - Logo - Texte

| QUANTITÉ | 1 | 15 | 30 | 50 | 100 | 200 |
|------------------|------------|------------|------------|------------|------------|------------|
| TARIF UNITAIRE | 39,00 € | 37,00 € | 35,00 € | 25,00 € | 15,00 € | 10,00 € |
| SUPPLÉMENT CADRE | 49,00 € | 47,00 € | 45,00 € | 35,00 € | 20,00 € | 15,00 € |

PLV - TABLEAU

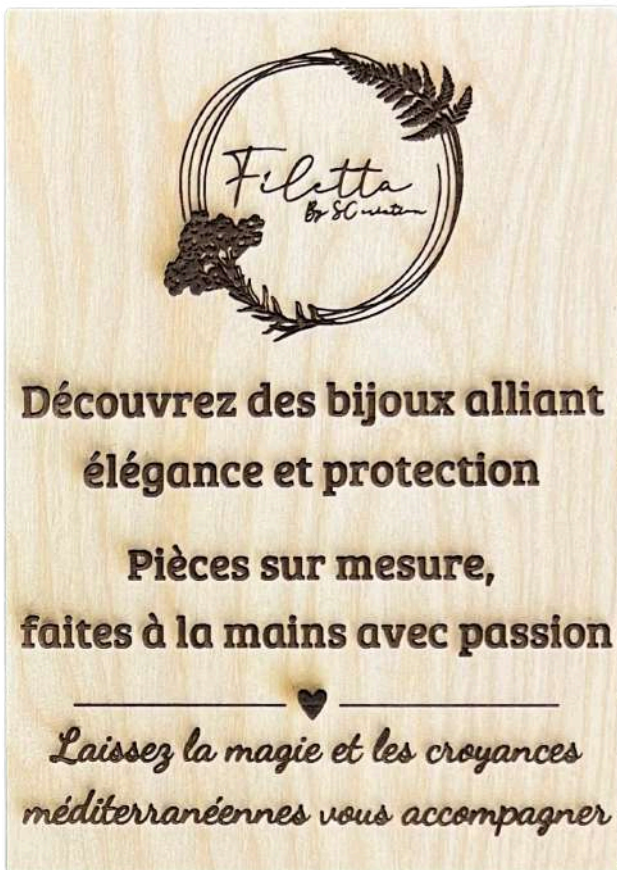

Dimension: A3 x 3 mm

Matériau: Contreplaqué de Tilleul

Gravure: Photo - Dessin - Logo - Texte

| QUANTITÉ | 1 | 15 | 30 | 50 | 100 | 200 |
|---------------------|------------|------------|------------|------------|------------|------------|
| TARIF UNITAIRE | 65,00 € | 63,00 € | 60,00 € | 45,00 € | 35,00 € | 25,00 € |
| SUPPLÉMENT CADRE | 79,00 € | 77,00 € | 74,00 € | 59,00 € | 47,00 € | 35,00 € |

PLV



Dimension: 105 x 148 x 3 mm

Matériau: Contreplaqué de Tilleul

Gravure: Dessin - Logo - Texte

| QUANTITÉ | 1 | 15 | 30 | 50 | 100 | 200 |
|----------------|------------|------------|------------|-----------|-----------|-----------|
| TARIF UNITAIRE | 15,00 € | 12,00 € | 10,50 € | 8,00 € | 7,00 € | 5,00 € |

PLV - TABLEAU



Dimension: 135 x 135 x 6 mm

Matériau: Contreplaqué de Tilleul

Gravure: Photo - Dessin - Logo - Texte

| | | | | | | |
|-------------------|------------|------------|------------|------------|------------|------------|
| QUANTITÉ | 1 | 15 | 30 | 50 | 100 | 200 |
| TARIF UNITAIRE | 25,00 € | 23,50 € | 22,00 € | 20,00 € | 15,00 € | 10,00 € |

PLV - TABLEAU



Dimension: 235 x 145 x 18 mm

Matériau: Bois de Pin

Gravure: Photo - Dessin - Logo - Texte

| QUANTITÉ | 1 | 15 | 30 | 50 | 100 | 200 |
|----------------------|------------|------------|------------|------------|-------------|------------|
| TARIF UNITAIRE | 29,00 € | 28,00 € | 27,00 € | 25,00 € | 20,00 € | 15,00 € |
| SUPPLÉMENT VERNIS | 39,00 € | 38,00 € | 37,00 € | 35,00 € | 28,00 €5 | 20,00 € |

PLV - TABLEAU

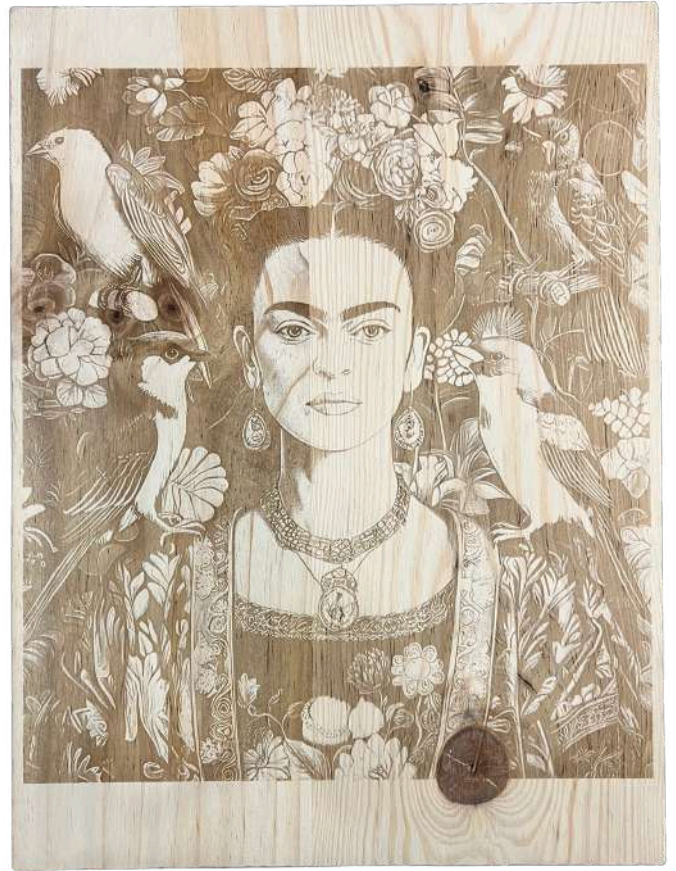

Dimension: 395 x 300 x 18 mm

Matériau: Bois de Pin

Gravure: Photo - Dessin - Logo - Texte

| | | | | | | |
|------------------------------|------------|------------|------------|------------|------------|------------|
| QUANTITÉ | 1 | 15 | 30 | 50 | 100 | 200 |
| TARIF UNITAIRE | 79,00 € | 75,00 € | 70,00 € | 50,00 € | 30,00 € | 25,00 € |
| SUPPLÉMENT VERNIS | 94,00 € | 90,00 € | 85,00 € | 65,00 € | 40,00 € | 35,00 € |

MÉDAILLE



Dimension: 65 x 3 mm

Matériau: Contreplaqué de Tilleul

Gravure: Dessin - Logo - Texte

| QUANTITÉ | 1 | 15 | 30 | 50 | 100 | 200 |
|---------------------|------------|------------|------------|------------|------------|------------|
| TARIF UNITAIRE | 15,00 € | 13,50 € | 12,00 € | 10,00 € | 8,00 € | 7,50 € |
| TARIF RECTO & VERSO | 18,00 € | 16,50 € | 15,00 € | 12,75 € | 10,50 € | 10,00 € |

TROPHÉE



Dimension: Sur mesure

Matériau: Contreplaqué de Tilleul

Gravure: Dessin - Logo - Texte

| | | | | | | |
|----------------|-----------|----|----|----|-----|-----|
| QUANTITÉ | 1 | 15 | 30 | 50 | 100 | 200 |
| TARIF UNITAIRE | Sur devis | | | | | |

CLÉ USB



Dimension: 135 x 135 mm

Matériau: Bois d'érable

Gravure: Dessin - Logo - Texte

| QUANTITÉ | 1 | 15 | 30 | 50 | 100 | 200 |
|------------------------|------------|------------|------------|------------|------------|------------|
| TARIF UNITAIRE | 29,00 € | 27,50 € | 25,00 € | 20,00 € | 17,00 € | 15,00 € |
| TARIF RECTO & VERSO | 32,00 € | 30,50 € | 28,00 € | 22,75 € | 19,50 € | 17,50 € |

ENSEIGNE PUBLICITAIRE



Dimension: 100 x 40 cm

Matériau: Bois de pin - CP de Tilleul

Gravure: Photo - Dessin - Logo - Texte

| QUANTITÉ | 1 | 15 | 30 | 50 | 100 | 200 |
|-------------------|----------|----------|----------|----------|-----------|-----------|
| TARIF UNITAIRE | 195,00 € | 190,00 € | 185,00 € | 180,00 € | sur devis | sur devis |
| SUPPLÉMENT VERNIS | 215,00 € | 210,00 € | 200,00 € | 195,00 € | sur devis | sur devis |

ENSEIGNE PUBLICITAIRE



Dimension: 100 x 50 cm

Matériau: Bois de pin - CP de Tilleul

Gravure: Dessin - Logo - Texte

| QUANTITÉ | 1 | 15 | 30 | 50 | 100 | 200 |
|-------------------|-----------------|-------------|-------------|-------------|--------------|--------------|
| TARIF UNITAIRE | 215,00 € | 210,00 € | 205,00 € | 200,00 € | sur devis | sur devis |
| SUPPLÉMENT VERNIS | 235,0 0 € | 230,00 € | 220,00 € | 215,00 € | sur devis | sur devis |

ENSEIGNE & SIGNALITIQUE



Dimension: Sur Mesure

Matériau: Bois de pin - CP de Tilleul

Gravure: Dessin - Logo - Texte

| | | | | | | |
|----------------|-----------|----|----|----|-----|-----|
| QUANTITÉ | 1 | 15 | 30 | 50 | 100 | 200 |
| TARIF UNITAIRE | Sur devis | | | | | |

ENSEIGNE PUBLICITAIRE



Dimension: Sur Mesure

Matériau: Bois de pin - CP de Tilleul

Gravure: Dessin - Logo - Texte

| | | | | | | |
|----------------|-----------|----|----|----|-----|-----|
| QUANTITÉ | 1 | 15 | 30 | 50 | 100 | 200 |
| TARIF UNITAIRE | Sur devis | | | | | |

DÉCOUPE LASER

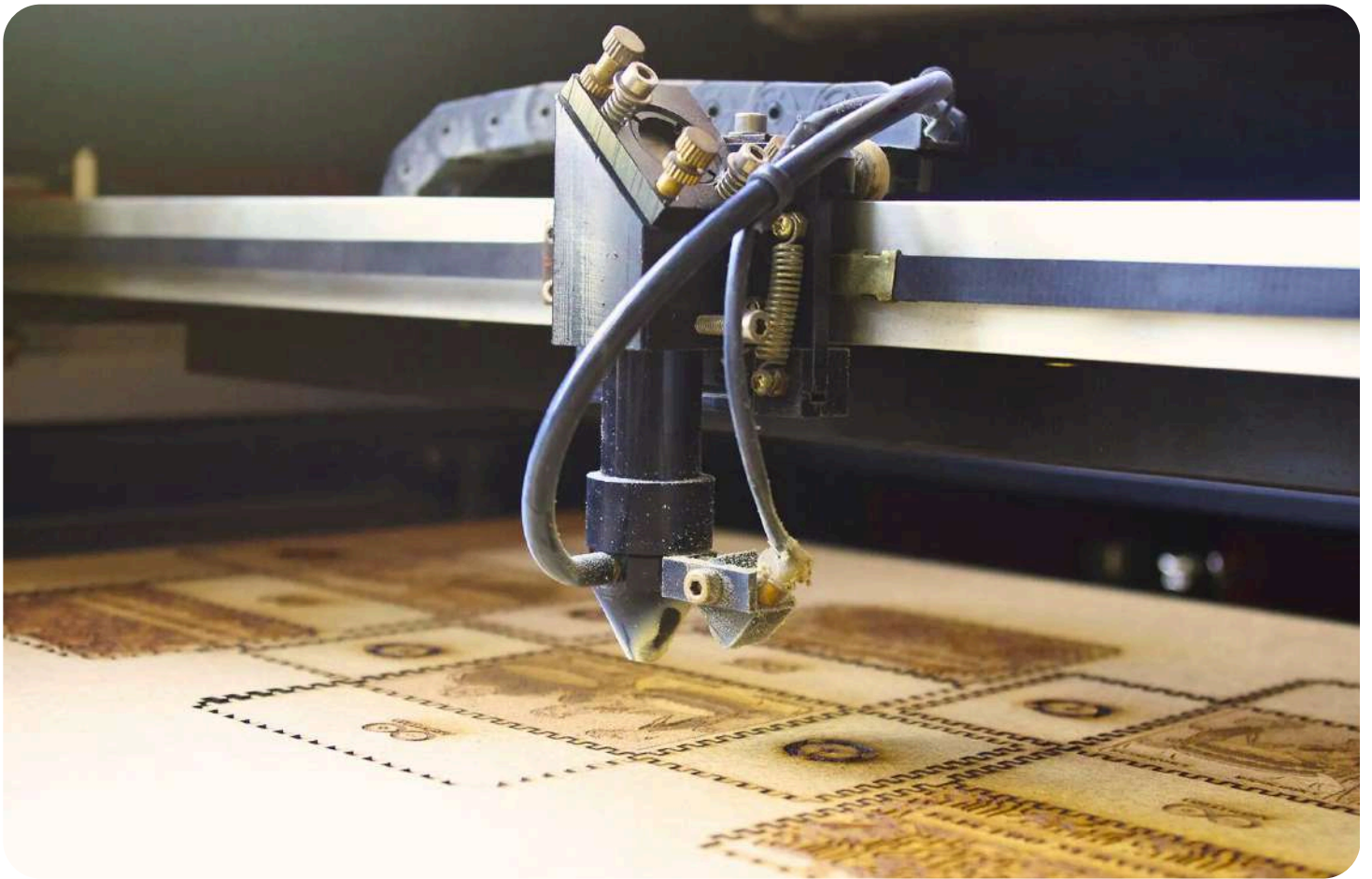

Dimension: Max 600 x 380 mm

Matériau: Bois

Gravure: Dessin - Logo - Texte

| | | | | | | |
|----------------|-----------|----|----|----|-----|-----|
| QUANTITÉ | 1 | 15 | 30 | 50 | 100 | 200 |
| TARIF UNITAIRE | Sur devis | | | | | |

GRAVURE LASER



Dimension: Max 600 x 380 mm

Matériau: Bois - Liège - Métaux - Cuir
- Pierre - Acrylique - ABS ...

Gravure: Dessin - Logo - Texte

| | | | | | | |
|-------------------|-----------|----|----|----|-----|-----|
| QUANTITÉ | 1 | 15 | 30 | 50 | 100 | 200 |
| TARIF UNITAIRE | Sur devis | | | | | |

IMPRESSION 3D FDM

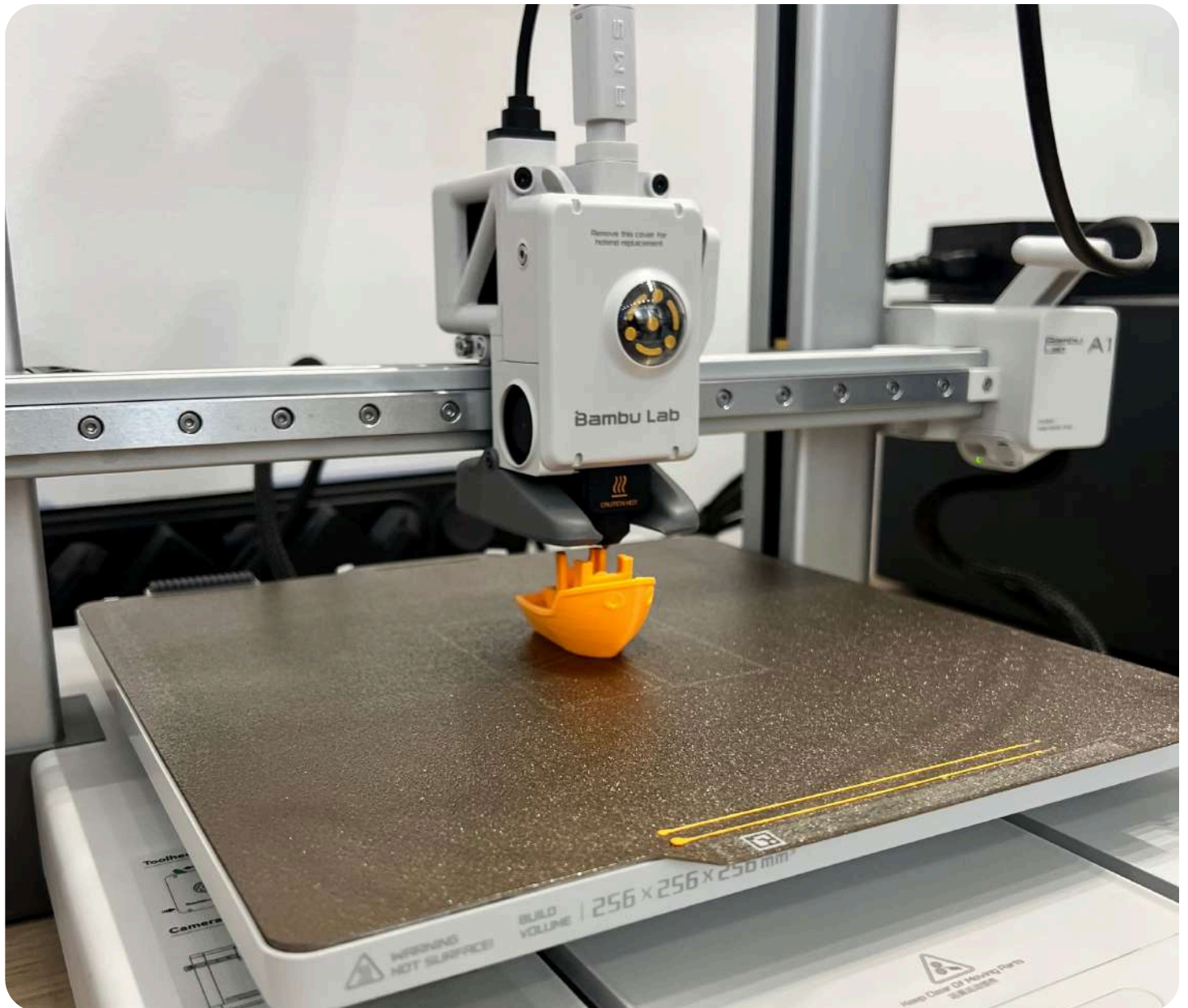

| | | | | | | |
|----------------|-----------|----|----|----|-----|-----|
| QUANTITÉ | 1 | 15 | 30 | 50 | 100 | 200 |
| TARIF UNITAIRE | Sur devis | | | | | |

IMPRESSION 3D SLA



| | | | | | | |
|----------------|-----------|----|----|----|-----|-----|
| QUANTITÉ | 1 | 15 | 30 | 50 | 100 | 200 |
| TARIF UNITAIRE | Sur devis | | | | | |

IMPRESSION SUR TEXTILE



Tshirt - Sweat - Jogging - Casquette - Tote Bag ...

| | | | | | | |
|----------------|-----------|----|----|----|-----|-----|
| QUANTITÉ | 1 | 15 | 30 | 50 | 100 | 200 |
| TARIF UNITAIRE | Sur devis | | | | | |

T-SHIRT



Taille: S à 5XL

Matériau: 100% coton

Impression: Dessin - Logo - Texte

Plusieurs couleurs disponibles

| QUANTITÉ | 1 | 15 | 30 | 50 | 100 | 200 |
|-------------------|------------|------------|------------|------------|------------|------------|
| TARIF UNITAIRE | 40,00 € | 18,50 € | 17,00 € | 15,00 € | 13,50 € | 12,80 € |



WHITE



BLACK



LIGHT GRAPHITE



HEATHER GREY



DESET SAND



NATURAL



DEEP NAVY



NAVY



MOUNTAIN BLUE



ROYAL BLUE



BOTTLE GREEN



CLASSIC OLIVE



COLLEGE GREEN



KELLY GREEN



CRANBERRY



BURGUNDY



DARK PLUM



MINERAL BLUE



POWDER ROSE



SOFT LAVENDER



SAGE



AZURE BLUE



RED



ORANGE



FUCHSIA



OCEAN TEAL



SUNFLOWER



TRUFFLE



ZINC



ATELIER AUTHENTIQUE

Artisanat & Innovation

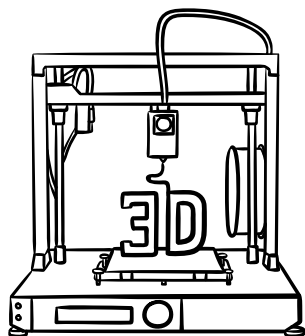

**IMPRESSION
3D**

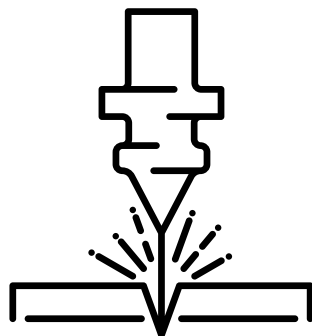

**GRAVURE ET
DÉCOUPE
LASER**

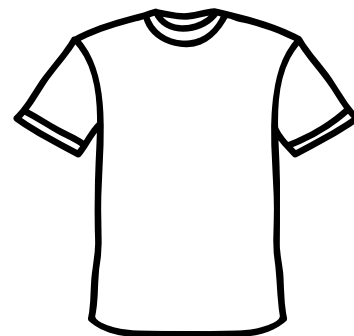

**IMPRESSION
SUR TEXTILE**

**CRÉATION
UNIQUE & SUR-MESURE**

Lucas SELLA



06-23-58-60-45



contact@atelier-authentique.com



**14 Rue Laurent Fauchier
13 100 Aix-en-Provence**



<https://atelier-authentique.fr>